



Meridian

MASSAGE CHAIR

Operation Instructions

SAVE THESE INSTRUCTIONS

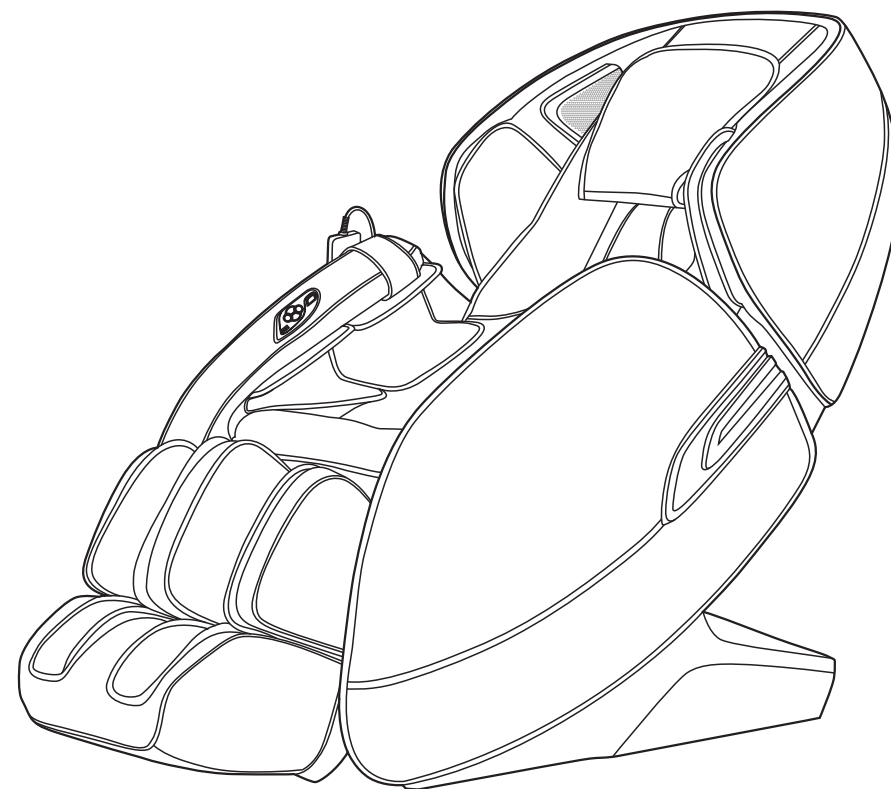

Thanks for purchasing the Infinity Meridian! Please read this manual carefully to learn how to use this product correctly before operation. Please pay attention to the safety warnings and store this manual in a convenient location for future use.

Note: Infinity Massage Chairs reserves the right to revise the design and description of this product without notice.

CONTENTS

Important Safety Instructions	02
Names and Functions of Components	04
Massage Chair Features	05
Operation Instructions	06
Assembly Instructions	11
Handling the Massage Chair	14
Product Specifications	15

IMPORTANT SAFETY INSTRUCTIONS

When using an electrical appliance, basic precautions should always be followed, including the following:

DANGER-To reduce the risk of electric shock:

- 1) Always unplug this appliance from the electrical outlet immediately after using and before cleaning.

WARNING-To reduce the risk of burns, fire, electric shock, or injury:

- 1) The massage chair should never be left unattended when plugged in. Unplug from outlet when not in use, and before putting on or taking off parts.
- 2) Do not operate under blanket or pillow. Excessive heating can occur and cause fire, electric shock, or injury.
- 3) Close supervision is necessary when this appliance is used by, on, or near children or disabled individuals.
- 4) Use the massage chair only for its intended use as described in this manual. Do not use attachments not recommended by the manufacturer.
- 5) Never operate the massage chair if it has a damaged cord or plug, is not working properly, has been dropped or damaged, or has water damage. Contact Infinity's technical support department at 603-910-5000 for assessment and repair.
- 6) Do not carry the massage chair by the power cord or use the cord as a handle.
- 7) Keep the power cord away from heated surfaces.
- 8) Never operate the massage chair with the air openings blocked. Keep the air openings free of lint, hair, and any other debris.
- 9) Never drop or insert objects into any opening.
- 10) Do not use outdoors.
- 11) Do not operate where aerosol (spray) products are being used or where oxygen is being administered.
- 12) To disconnect, turn all controls to the off position, then remove plug from outlet.
- 13) The massage chair is intended for household and indoor use only.
- 14) Keep children away from extended footrest.
- 15) Do not wear excessively loose clothing or jewelry while using the massage chair.

SAVE THESE INSTRUCTIONS

Name and Function of Components

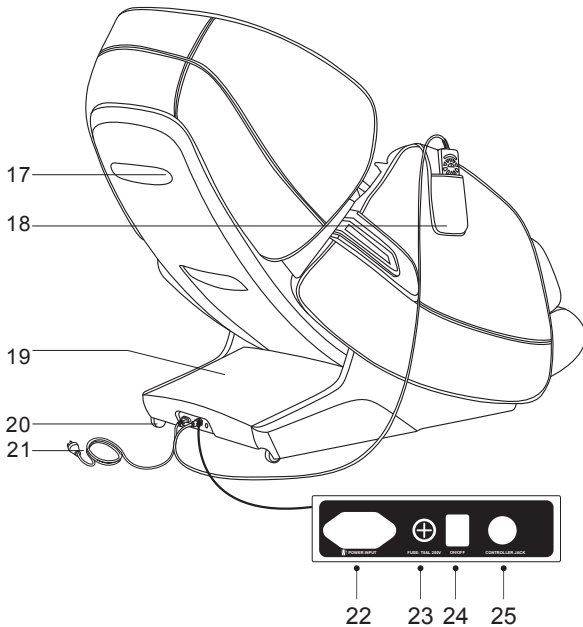
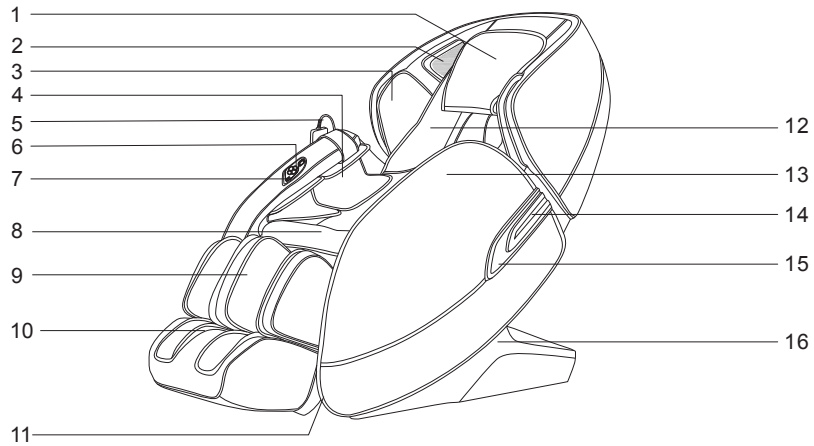

1. Head Cushion
2. Audio Speakers & Oxygen Ionizer
3. Upper Arm Airbag Components
4. Arm Airbag Components
5. Controller
6. Convenient Built-in Remote
7. USB Charging Port
8. Seat Cushion
9. Leg Rest Frame
10. Foot Rest Frame
11. Calf Rest Back Cover
12. Back Cushion
13. Armrest
14. LED Lights
15. Armrest Decoration
16. Side Cover
17. Back Cover
18. Controller Pocket
19. PCB Box Cover
20. Moving Wheels
21. Power Cord
22. Power Cord Socket
23. Fuse Box
24. Power Switch
25. Controller Cord Socket

Massage Chair Features

- The Meridian is designed with a four-wheel massage mechanism that can move up and down as well as side to side.
- Enjoy five massage techniques: shiatsu, kneading, tapping, knocking, and a combination of kneading and tapping.
- The chair's automatic shoulder detection and micro adjustment function ensures an accurate massage.
- Quickly and easily choose from six automatic programs: Recover, Soothe, Demo, Relax, Shoulders & Neck, and Waist & Spine.
- Create and save up to two custom massage programs with two memory functions: M1 and M2.
- When in manual mode, you can choose from five types of massage coverage: Overall, Partial Area, Fixed Spot, Upper Back Partial Area, and Lower Back Partial Area. Then select which massage technique you'd like. Each method includes three speed levels.
- When in the Fixed Spot and Partial Area modes, the massage mechanism can be moved up and down to reach an exact point.
- During Tapping, Shiatsu, and Knocking techniques, you can also set the width of the massage rollers to one of three options: Wide, Medium, and Narrow.
- The Meridian features a full body airbag massage, with the option to turn on all airbags or only certain zones. Choose from Full Body Air Pressure Massage, Arms Air Pressure Massage (4 air bags in the upper arms and 8 airbags in the forearms), and Legs Air Pressure Massage (16 airbags). There are also three intensity levels.
- The chair's leg rest is designed with with rollers in the sole of each foot. Additionally, the foot units include a unique heel rubber to massage the arch and heel.
- Lumbar heat in the back of the chair loosens tense, sore muscles to prepare your body for massage.
- The foot rest can be extended to accommodate a wide range of user heights.
- The Meridian's space-saving technology slides the chair forward as the back rest reclines, allowing users to place it in more compact places.
- Place the chair in zero gravity mode for the ultimate relaxation, or adjust the leg rest and back rest manually to your preference.
- The chair's unique L-shaped track allows the massage rollers to follow all of your curves and hit those troublesome spots from the neck down through the glutes. It even maintains full reach when in the zero gravity position.
- Play your favorite tunes or soundscapes by connecting your smart phone or tablet device to the Bluetooth-enabled speakers in the headrest area.
- Revitalize your senses with the Meridian's air ionizer, located next to the speakers.
- LED lights on the outside of each armrest use chromotherapy to improve mood.
- The convenient built-in remote on the right armrest allows you to quickly turn the chair on or off, set the zero gravity position, toggle between auto programs, and dual recline or dual incline.
- Charge your devices with the handy USB charger on the right armrest.
- The head cushion features two sections and a collapsible design (two levels when folded) so that you can adjust for comfort. Reduce the massage intensity in the neck area by folding the cushion up, or unfold it to add an extra layer to the back area and reduce the back massage intensity.

Operation Instructions

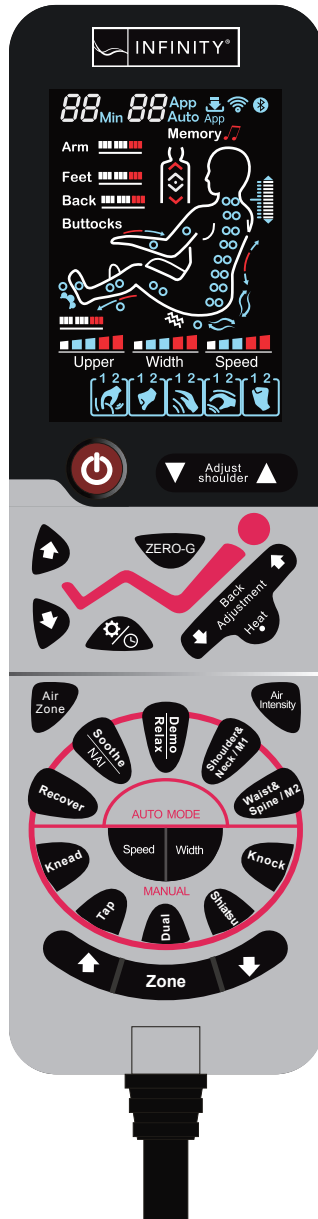

06

Operation Instructions

1. Switch power supply on.

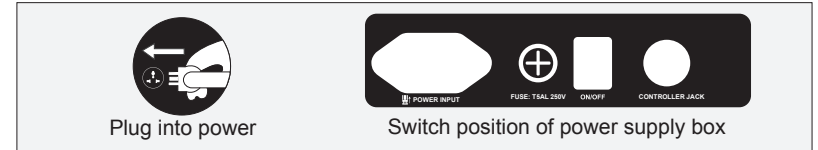

2. Start your massage.

- 1) Press the power button. The massage chair will automatically begin reclining and then start a massage.
- 2) The automatic shoulder position and acupressure point detection will also run.
- 3) You can also adjust the shoulder position by using the up and down buttons according to your preferences. The shoulder position has 10 adjustment levels. If no adjustment is made to the shoulder position within 10 seconds, it will begin an auto massage program.

Button	Description	Display
Adjust shoulder	Move the massage rollers upward to a suitable position.	
	Move the massage rollers downward to a suitable position.	

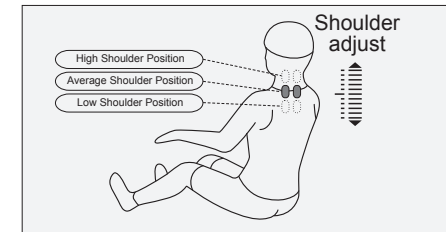

4) Choose your massage function.

- To Select a Memory Massage: Press the “Shoulders & Neck / M1” or “Waist & Spine / M2” button for 3 seconds. The chair will then begin your selected memory massage.

Function	Button	Display
Memory Massage	Shoulder & Neck / M1	Memory
	Waist & Spine / M2	Memory

07

Operation Instructions

• Auto Massage Programs

Function	Button	Feature	Display
Auto Massage Programs		Deeply massages acupressure points, effectively alleviates pain	Auto A1
		Loosens sore, tense muscles	Auto A2
		Relax: Promotes blood circulation	Auto A3
		Demo: Press for two seconds to switch to Demo mode and briefly experience each auto program.	Auto A0
		Focuses on neck and shoulders	Auto A4
		Focuses on waist and spine	Auto A5

• Upper Body Manual Massage

Function	Button	Adjust Massage Rollers	Display
Technique		Speed and Width	
		Speed	
		Speed and Width	
		Speed	
		Speed and Width	
Speed		Three Levels of Speed	
Width		Three Width Settings	

• Air Pressure Massage Function

Function	Button	Description	Display
Air pressure mode		Three Air Pressure Modes (Full Body, Arms, and Legs)	Arm Feet
Intensity		Three Intensity Levels	Arm Feet

Operation Instructions

• Message Zone Adjustments

Function	Button	Description	Display	
ZONE		Fixed spot massage		
		Partial area massage		
		Overall massage		
		Upper back massage		
		Lower back massage		
		Adjust the massage point. (In fixed spot and partial modes you can adjust the massage roller position.)	Moves massage roller up	
			Moves massage roller down	

• Other Manual Functions







Function	Button	Description	Display
Roller		Turns on foot rollers. Three speed levels available.	
Time		The default working time is 10 minutes, max working time is 30 minutes. Press for 3 seconds to add 10 minutes. You can set the time range from 1 to 30 minutes.	
Heating		Turns on infrared heat function. This function takes three minutes to warm up.	
Negative Oxygen Ionizer		Press for three seconds to turn the negative oxygen ionizer on or off.	

• Other Manual Functions

Function	Button	Description
Leg Rest Adjustment		Hold this button to raise the leg rest slowly. Release to stop.
		Hold this button to lower the leg rest slowly. Release to stop.
Backrest Adjustment		Hold this button to raise the backrest slowly. Release to stop.
		Hold this button to recline the leg rest slowly. Release to stop.
Zero Gravity		Press this button to go into zero gravity mode, which reclines the chair and raises your knees above your heart to improve circulation. There are three zero gravity modes.

Operation Instructions

- Built-in Arm Rest Remote

Function	Button	Description
On/off		Press this button to turn the chair on or off.
Auto modes		Press one time to switch to the next auto massage function.
Dual Recline		Press and hold this button to slowly lower the backrest and lift the leg rest. Release the button to stop.
Dual Incline		Press and hold this button to slowly lift the backrest and lower the leg rest. Release the button to stop.
Zero Gravity		Press one time to switch to the next of the three zero gravity position.
USB		Charge your smart phone or tablet on the convenient USB charger.

3. Turn off power and stop massage.

- 1) Press the power button during your massage to stop all functions immediately. The backrest and foot rest will return to their original positions automatically. After your set massage time is up, all massage functions will be complete; however, the backrest and footrest won't return to the original position. Meanwhile, you can save your completed massage to your memory programs if you wish to do so.

- **Memory Save Function:** Select your manual massage settings (i.e., speed, technique, air intensity, etc.). Let the massage run for a moment, then press the power button to turn it off (or you can wait until the end of your manual program, at which point the chair shuts down automatically). After a moment, the word "Memory" will blink on the remote screen. This gives you the option to save the massage mode before the chair fully turns off. Press the memory function buttons "M1" or "M2" as you like to store the massage mode.

- 2) Turn off power for the whole massage chair.

Figure (Switch power off)

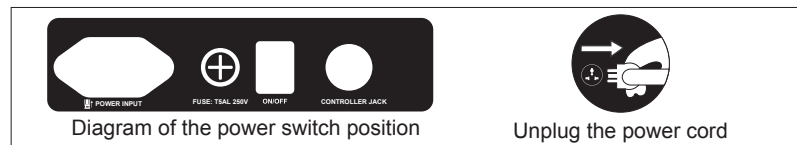

Assembly Instructions

1. Installing the Arm Rests

- Find the coupling plug from the seat frame base that fits the plug on the corresponding arm rest. Pull them up through the middle of the seat frame.
- Connect each plug according to the marks on each wire. (Figure 2)

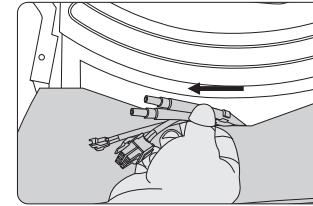

Figure 1

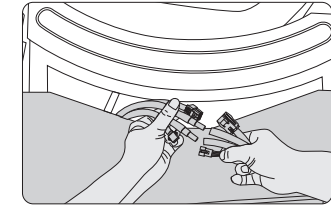

Figure 2

- After securely connecting each plug and air hose from the chair to the corresponding plugs on the arm rest, gently rest the arm rest beside the chair. (Figure 3)
- Tuck the wires back in the seat frame base along with the metal tube, then put on the cloth cover. Avoid folding the air hose. (Figure 4)

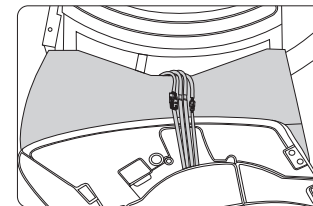

Figure 3

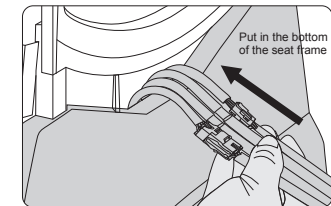

Figure 4

- Use two hands to hold the ends of the arm rest and align the connections on the rear of the arm rest with the connections on the chair. Screw in to secure. (Figure 5)
- Attach the decorative cover. (Figure 6)

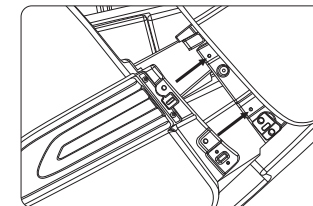

Figure 5

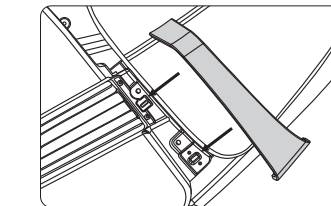

Figure 6

Assembly Instructions

- After connecting the rear of the arm rest, align the front part of the arm rest with the metal tube and insert the hook on the front of the arm rest to the corresponding seat frame metal tube. (Figure 7)
- Press the arm rest downward until it is properly in place, then push the front of the arm rest upward. Align the hook on the arm rest with the metal tube on the front of the chair. Move the arm rest gently to ensure it is attached well. (Figure 8)

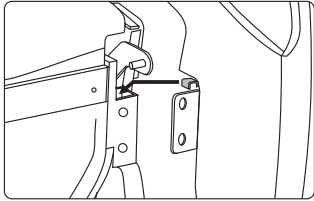

Figure 7

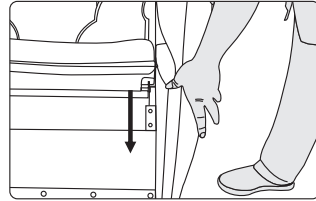

Figure 8

- Align the hole on the metal tube with the corresponding piece on the front of the arm rest. Tighten the Phillips head screw on the arm rest frame with a Phillips head screw driver. (Figure 9)
- After completing installation on one side, repeat the above steps for the other arm rest.

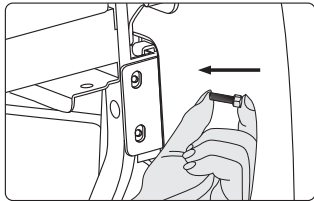

Figure 9

2. Installing the Leg Rest

- Install the rotating shaft on the fixed axis on the leg rest. Align the hole on the assembly for the R-shaped pin, as shown below. (Figure 1)
- Attach the leg rest to the chair body. (Figure 2)

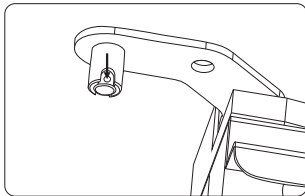

Figure 1

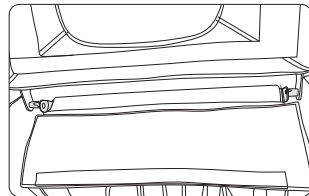

Figure 2

Assembly Instructions

- Connect the R pin on one side, and then on the other. (Figure 3)
- The leg rest installation is complete. (Figure 4)

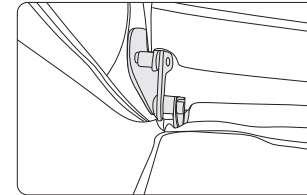

Figure 3

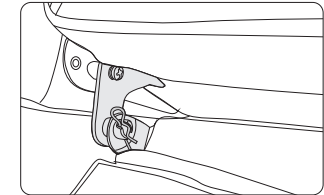

Figure 4

Note

- When the chair is operating in zero gravity position and the calf rest is raised, do not press on the calf rest, as this could cause the chair to fall forward and cause injury.
- Ensure that the massage roller mechanism is in the original position when you sit down in order to avoid discomfort on your gluteus muscles.

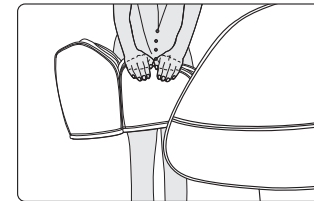

Figure 1

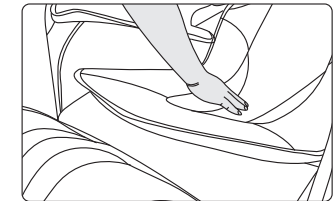
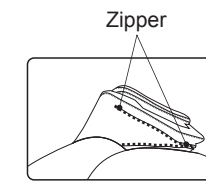
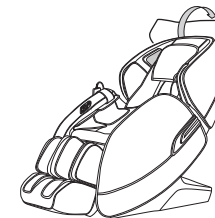

Figure 2

3. Attaching the Headrest Cushion and Back Rest Pad

- Using the headrest and back cushions can reduce the massage intensity on your neck and shoulders. You can decide how to use the cushions based on your preferences. The back pad connects to the back rest by a zipper (1), while the head cushion and back pad are connected by Velcro (2).



(1)

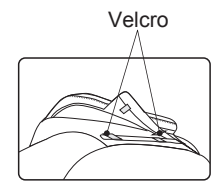

(2)

Handling the Massage Chair

1. Floor Protection

- Since the massage chair is so heavy and may damage your floor, we advise placing a carpet or other protective covering under it to avoid such damage.

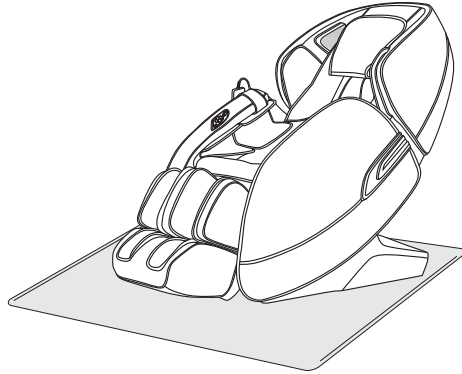

Caution: Do not move the chair with its wheels on a wood floor, rough ground, or in a narrow space. We advise that two people lift the chair. Use the back of the calf rest and the grooves on the back of the back rest to lift. Do not lift the chair by the arm rests.

2. Moving the Chair

- Ensure that no wires are hanging or dragging on the ground, then tilt the back rest backward (with the gravity center resting on the wheels). Push the chair forward or pull backward with your hands, then lower the chair slowly until it is level on the floor again.

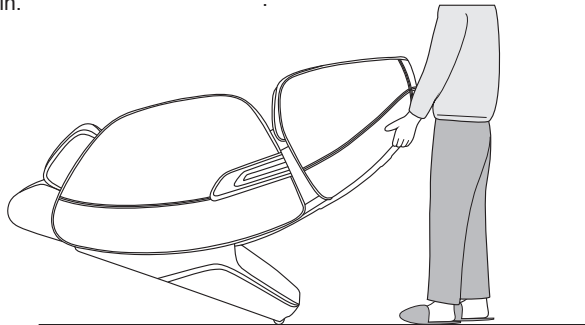

Note: Turn off the power and unplug the power cord and the remote control before moving the chair.

Product Specifications

Model: Meridian
 Name: Massage Chair
 Rated voltage: 110-120V~ 60Hz
 Rated power input: 150W
 Rated time: 20 min
 Safety structure: Class I

Dimensions (L x W x H)
 Main Body: 57 x 18 x 36 in.
 Arm Rests: 26 x 14 x 45 in.

Weight
 202.82 + 50.71 lbs

Max. User Weight
 330 lbs

Materials include: PVC, PA, steel parts and electrical parts.

MATERIAL	PU	LEATHER	CLOTH	WOOD